



Royce

LINEA GERENCIAL Y OPERATIVA



Su diseño de vanguardia hace de esta línea una de las más codiciadas del mercado, ideal para muebles gerenciales. Su estructura en aluminio de 2mm ofrece varias posibilidades que se adaptan a las necesidades de los usuarios más exigentes.

Descripción: estructura de aluminio Oval de 1.6mm de espesor.

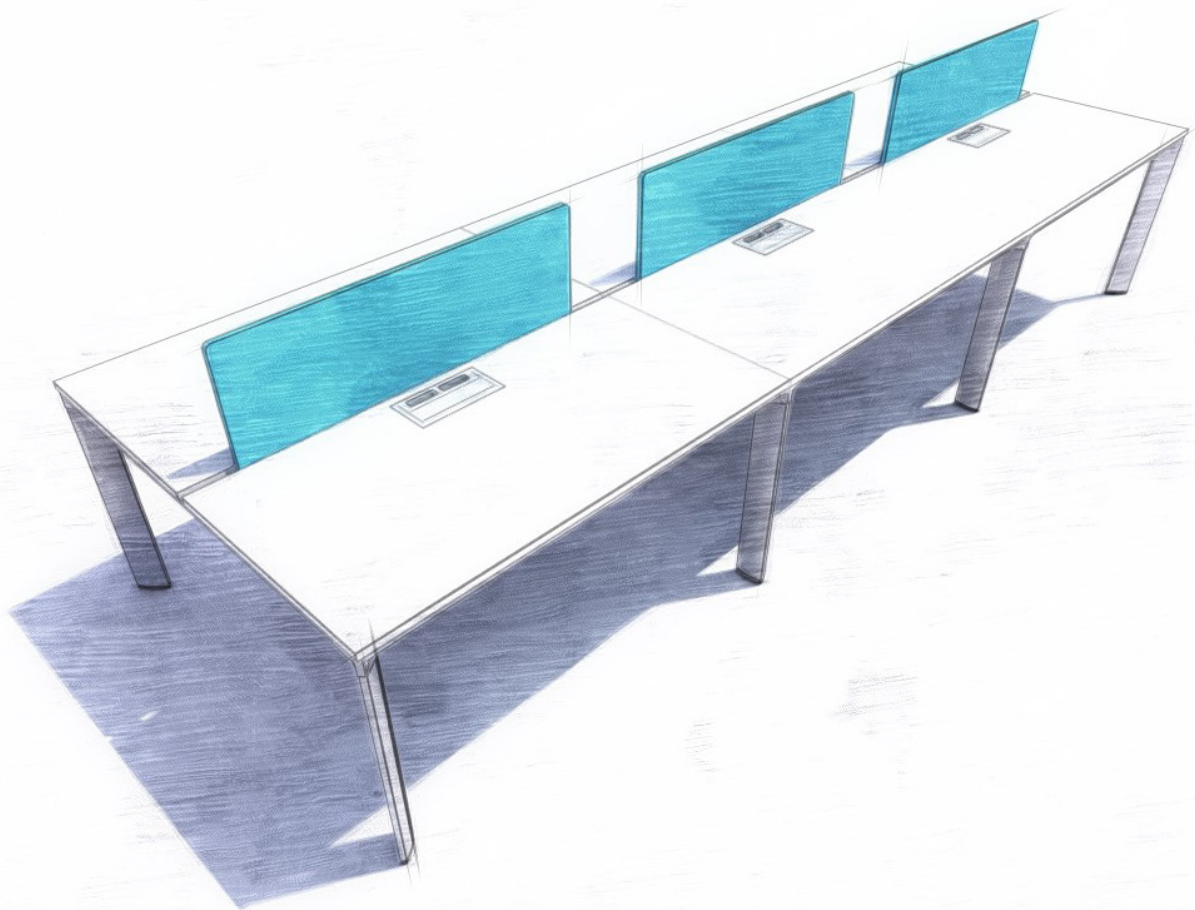

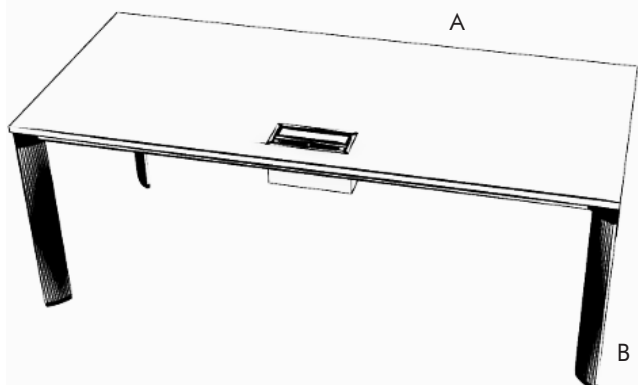

Modelo: ERY

Medidas disponibles:

- tapa 25mm A 1000
- tapa 25mm A 1200
- tapa 25mm A 1400
- tapa 25mm A 1600
- tapa 25mm A 1800

Disponibles en B 600 o B 700

Altura Escritorio 750 mm

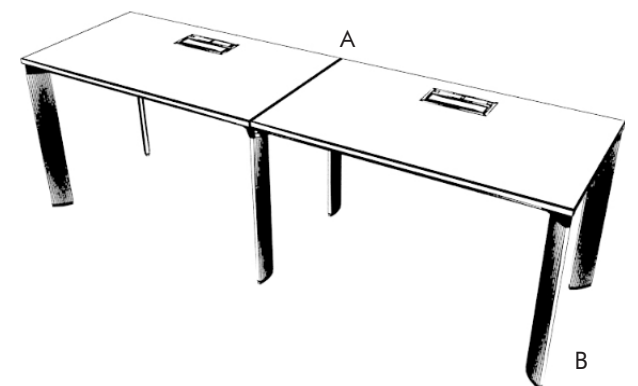

Modelo: ERY2

Medidas por modulo de trabajo disponibles:

- tapa A 1000: A 2000 final
- tapa A 1200: A 2400 final
- tapa A 1400: A 2800 final
- tapa A 1600: A 3200 final

Disponibles en B 600, B 700

Altura Escritorio 750 mm

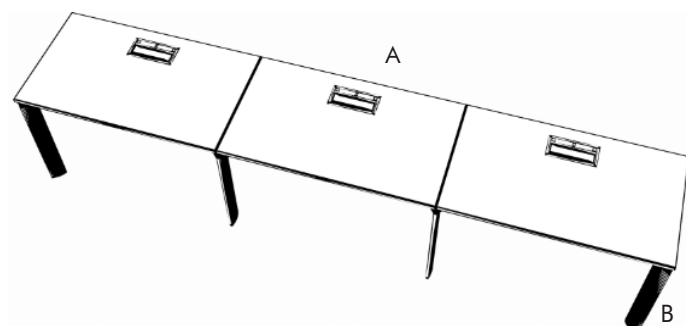

Modelo: ERY3

Medidas por modulo de trabajo disponibles:

- tapa A 1000: A 3000 final
- tapa A 1200: A 3600 final
- tapa A 1400: A 4200 final
- tapa A 1600: A 4800 final

Disponibles en B 600 o B 700

Altura Escritorio 750 mm

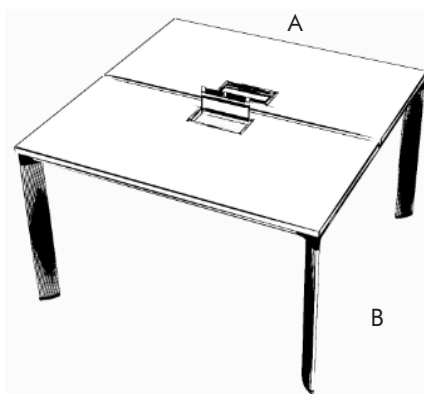

Modelo: ERYM2

Medidas disponibles:

- tapa A 1000mm:
- tapa A 1200mm:
- tapa A 1400mm:
- tapa A 1600mm:

Disponibles en B 1200, B1400 de ancho.

Altura Escritorio 750 mm

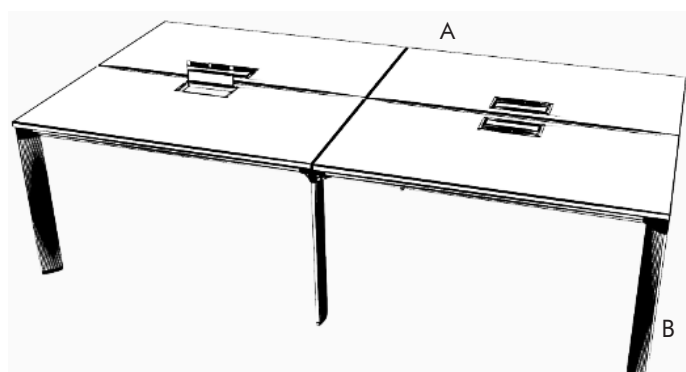

Modelo: ERYM4

Medidas por modulo de trabajo disponibles:

- tapa A 1000: A 2000 final
- tapa A 1200: A 2400 final
- tapa A 1400: A 2800 final
- tapa A 1600: A 3200 final

Disponibles en B 1200, B1400 de ancho.

Altura Escritorio 750 mm.

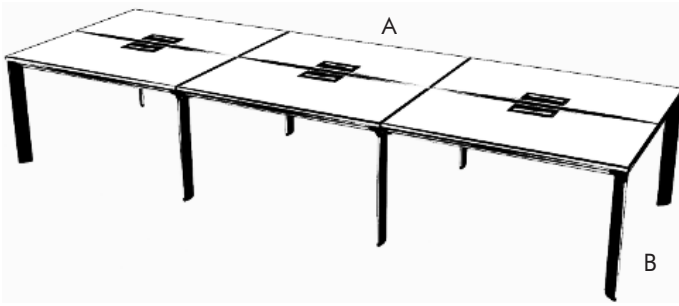

Modelo: ERYM6

Medidas total disponibles:
 tapa A 1000:A 3000 final
 tapa A 1200:A 3600 final
 tapa A 1400:A 4200 final
 tapa A 1600:A 4800 final

Disponibles en B 1200, B1400 de ancho.

Altura Escritorio 750 mm.

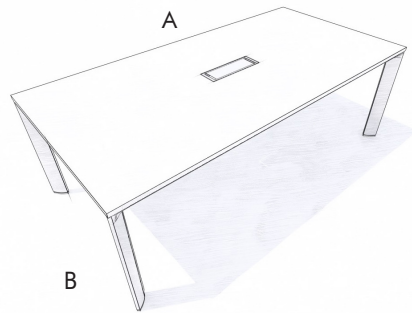

Modelo: MRR2211

Mersa de reunión de A 2200x B 1100x750mm

incluye tapa pasacable de 3 tomas

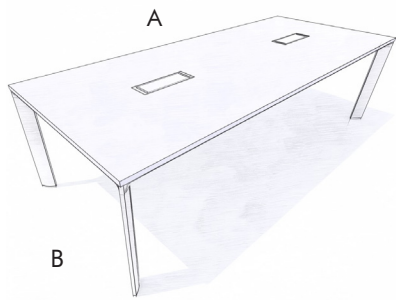

Modelo: MCHR2711

Mesa de reunión de A 2700xB 1100x750mm

Incluye tapa pasacable de 3 tomas

Colores disponibles:
 Lisos: Tapa 25mm de espesor canto abs 2mm

Blanco



Aluminio



Ceniza

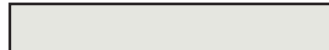

Colores disponibles:
 Madera: Tapa 18 mm de espesor canto abs 1mm

Roble americano



Cedro



Teka oslo



Roble natural



Wengue



Color de estructura disponibles: Terminaciones en liso y microtexturado.

Blanco

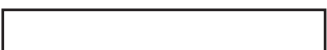

Aluminio



Negro



Cajoneras pedestal



Modelo: CP1

Medidas disponibles:
400x450x715mm
450x450x715mm

incluye cerradura



Modelo: CP2

Medidas disponibles:
400x450x715mm
450x450x715mm

incluye cerradura



Modelo: CP3

Medidas disponibles:
400x450x715mm
450x450x715mm

incluye cerradura

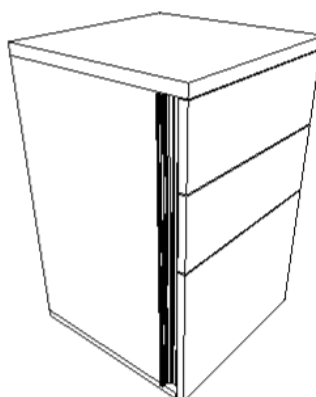

Modelo: CPM

Medidas disponibles:
400x450x715mm
450x450x715mm

incluye cerradura

Cajoneras rodante



Modelo: CR1

Medidas disponibles:
400x450x630mm
450x450x630mm

incluye cerradura



Modelo: CR2

Medidas disponibles:
400x450x630mm
450x450x630mm

incluye cerradura



Modelo: CR3

Medidas disponibles:
400x450x630mm
450x450x630mm

incluye cerradura

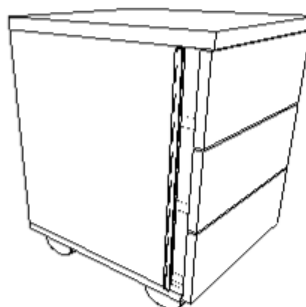

Modelo: CRM

Medidas disponibles:
400x450x630mm
450x450x630mm

incluye cerradura

n.

Cajoneras gerenciales



Modelo: GSG-X3

Medidas disponibles:
1600x450x605mm
1700x450x605mm

incluye cerradura



Modelo: CGG

Medidas disponibles:
1200x450x605mm
1400x450x605mm
1600x450x605mm

incluye cerradura



Modelo: CG

Medidas disponibles:
900x450x605mm

incluye cerradura

Accesorios

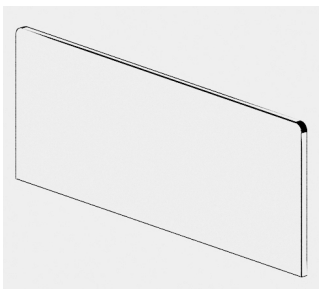

Modelo: M

Mampara divisora de 18mm
disponible en:

800 x 18 x 350 mm
1000 x 18 x 350 mm
1200 x 18 x 350 mm
1400 x 18 x 350 mm
1600 x 18 x 350 mm
1800 x 18 x 350 mm

disponible en melamina y
laqueada.

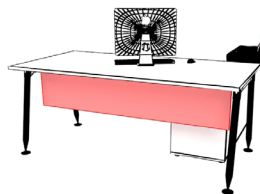

Modelo: CUP

Cubrepiernas de 18mm
disponible en:

1000 x 18 x 370 mm
1200 x 18 x 370 mm
1400 x 18 x 370 mm
1600 x 18 x 370 mm
1800 x 18 x 370 mm
2000 x 18 x 370 mm

disponible en melamina y
laqueada.

Regruesos

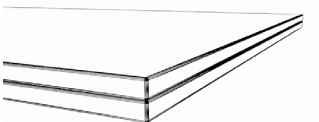

Modelo: R18

Regrueso de 18+18

Aplicación por metro lineal.

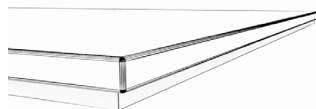

Modelo: RA

Regrueso de 18+ barra de
aluminio

Aplicación por metro lineal.

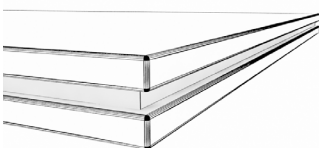

Modelo: R18

Regrueso de 18+aluminio+18

Aplicación por metro lineal.

Colores disponibles:

Lisos: Top de 25mm de espesor canto abs 1mm

Blanco



Aluminio



Ceniza



Colores disponibles:

Madera: Top de 18 mm de espesor canto abs 1mm

Roble americano



Cedro



Teka oslo



Roble natural



Wengue

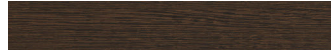

Consultar por mas colores, trabajamos linea Faplac y Egger.

Conectividad

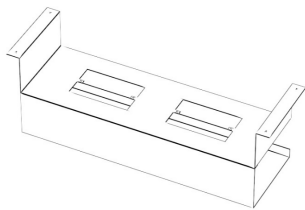

Modelo: CPTC 2

Bandeja portatoma:
Apto para 2 bastidores.

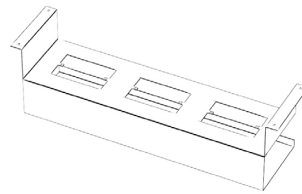

Modelo: CPTC 3

Bandeja portatoma:
Apto para 3 bastidores.

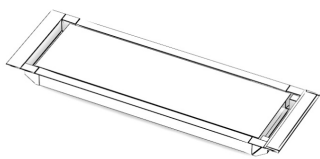

Modelo: TCP-FX

Tapa pasacable:
Disponible para bandeja de 2
y 3 bastidores

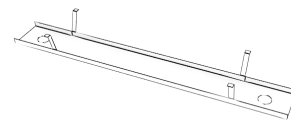

Modelo: BSPT

Bandeja portatoma:
Capacidad para 4 bastidores.
Disponibles en:

1000x150mm
1200x150mm

1000x270mm
1200x270mm

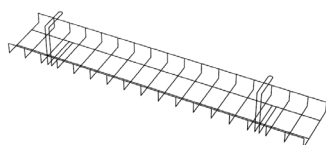
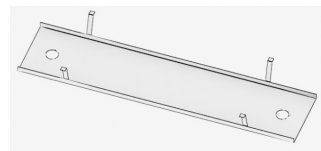

Modelo: BPC-F

Bandeja pasacable alambrada:

1000x270mm
1200x270mm

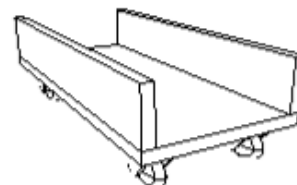

Modelo: P-CPU

Porta cpu rodante:
250x500x160